



DELTA

Die Kästen der Serie Delta sind aus Polypropylen hergestellt und haben eine kegelstumpfförmige Struktur: Sie sind im voll belasteten Zustand stabil und sicher übereinanderstellbar und werden im Leerzustand ineinander gesteckt, wodurch ihr Volumen um 70% reduziert wird.

Dank dieser Eigenschaften werden sie für eine ideale Raumnutzung in Lagern und vor allem für Transporte verwendet: Ganz besonders bei Transporten mit Leergut-rücksendungen bzw. immer wenn die Verpackung den kleinstmöglichen Platz einnehmen soll.

GRIFFE

Die Griffleisten versichern ein einfaches und sicheres Heben auch mit Handschuhen



Stapelbarkeit mit geschlossenem Behälter

Insichgestapelt mit offenem Behälter



Stapelbarkeit mit Halteleisten

Insichgestapelt mit eingeklappten Halteleisten

Vorne



HALTERUNGEN

Die Halterung (Abb. 1) wird bis zum Anschlag geschoben (Abb. 2) und durch Druck nach unten blockiert (Abb. 3).



Blockierung der Halterung

ROHSTOFF

CODIERUNG DELTA

PP

51 01

Polypropylen, grau

PP

51 XB

Polypropylen, türkis

ESD

52 07

PP - ESD schwarz

LF

59 00

PP - weiß lebensmitteltauglich

W

5A 01

graues wiederverwertetes Material



- 0 = ohne Kennzeichnung
- 1 = Kennzeichnung mit Schieber
- 2 = IML-Kennzeichnung für Bestellungen von mehr als 2000 Stk.
- 3 = Heißkennzeichnung

Konfiguration Wände und Böden				Material	Farbe
FP	DE	6422	A 0 0	51	01
Kastenserie		Höhe	Tiefe	Breite	

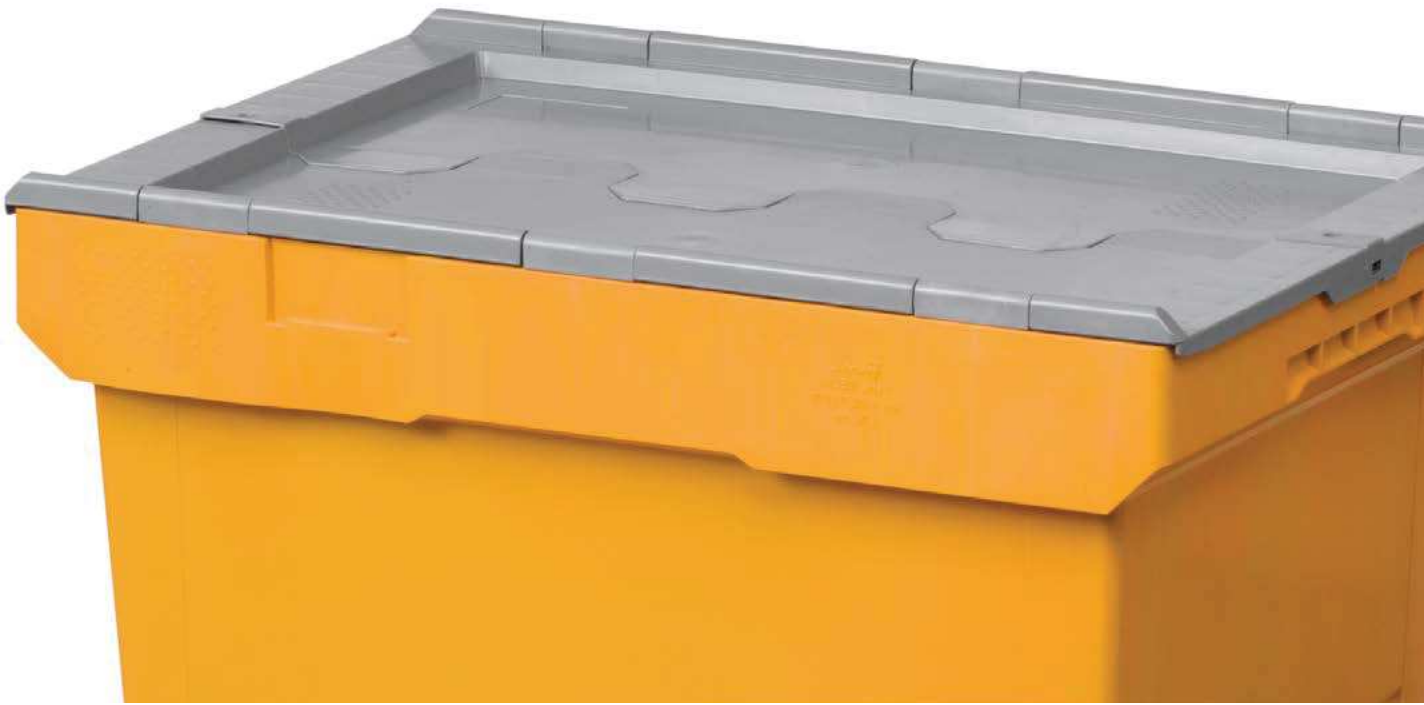
- 0 = ohne Strichcode
- 1 = Paar Strichcodes lange Wände
- 2 = Paar Strichcodes kurze Wände
- 3 = Paar Strichcodes lange/kurze Wände



VERPACKUNG 3 - PALETTE

Kasten- höhe mm	ART.	Abm. Palette mm			
225 H	FY DE 6422 A 00	51 01	1200x800x2100 H	136	38
		51 XB			
		52 07			
		5A 01			
		59 00			
240 H	FY DE 6422 C 00	51 01	1300x1100x2050 H	104	38
		51 XB			
		52 07			
		5A 01			
		59 00			
230 H	FY DE 6422 B 00	51 01	1200x800x2100 H	136	38
		51 XB			
		52 07			
		5A 01			
		59 00			
325 H	FY DE 6432 A 00	51 01	1200x800x2000 H	80	58
		51 XB			
		52 07			
		5A 01			
		59 00			



A



B



C



VERPACKUNG 1
Menge pro Karton



VERPACKUNG 2
Anz. Kästen
pro 1/2 Palette



VERPACKUNG 3
Anz. Kästen
pro Palette









Litervolumen
pro Einzelkasten



PERSONALISIERTE
KENNZEICHNUNG
siehe S. 9



VERPACKUNG 1 - KARTON

VERPACKUNG 2 - 1/2 PALETTE

Kasten- höhe mm	ART.		Abm. Karton mm			Kasten- höhe mm	ART.		Abm. 1/2 Palette mm		
340 H	FW DE 6432 C 00	51 01	520x640x900 H	7	58	340 H	FX DE 6432 C 00	51 01	1300x1100x1200 H	32	58
		51 XB						51 XB			
		52 07						52 07			
		5A 01						5A 01			
		59 00						59 00			
330 H	FW DE 6432 B 00	51 01	425x620x670 H	5	58	330 H	FX DE 6432 B 00	51 01	1200x800x1200 H	40	58
		51 XB						51 XB			
		52 07						52 07			
		5A 01						5A 01			
		59 00						59 00			
425 H	FW DE 6442 A 00	51 01	425x620x670 H	3	74	425 H	FX DE 6442 A 00	51 01	1200x800x1200 H	28	74
		51 XB						51 XB			
		52 07						52 07			
		5A 01						5A 01			
		59 00						59 00			
440 H	FW DE 6442 C 00	51 01	520x640x900 H	5	74	440 H	FX DE 6442 C 00	51 01	1300x1100x1200 H	24	74
		51 XB						51 XB			
		52 07						52 07			
		5A 01						5A 01			
		59 00						59 00			
430 H	FW DE 6442 B 00	51 01	425x620x670 H	3	74	430 H	FX DE 6442 B 00	51 01	1200x800x1200 H	28	74
		51 XB						51 XB			
		52 07						52 07			
		5A 01						5A 01			
		59 00						59 00			



VERPACKUNG 3 - PALETTE

Kostenhöhe mm	ART.		Abm. Palette mm		
340 H	FY DE 6432 C 00	51 01	1300x1100x2200 H	76	58
		51 XB			
		52 07			
		5A 01			
		59 00			
330 H	FY DE 6432 B 00	51 01	1200x800x2000 H	80	58
		51 XB			
		52 07			
		5A 01			
		59 00			
425 H	FY DE 6442 A 00	51 01	1200x800x2120 H	64	74
		51 XB			
		52 07			
		5A 01			
		59 00			
440 H	FY DE 6442 C 00	51 01	1300x1100x2100 H	56	74
		51 XB			
		52 07			
		5A 01			
		59 00			
430 H	FY DE 6442 B 00	51 01	1200x800x2120 H	64	74
		51 XB			
		52 07			
		5A 01			
		59 00			



A



B



C



VERPACKUNG 1
Menge pro Karton



VERPACKUNG 2
Anz. Kästen pro 1/2 Palette



VERPACKUNG 3
Anz. Kästen pro Palette



Litervolumen pro Einzelkasten



PERSONALISIERTE KENNZEICHNUNG
siehe S. 9



DELTA 600x400 ZUBEHÖRE



2-TEILIGER KLAPPDECKEL

ART.		Abm. mm	
FP DE 64HG 000	51 01	610x400	
	51 XB		
	52 07		
	5A 01		
	59 00		

LAGERHALTIG

AUF ANFRAGE



ERSATZSCHARNIERE

ART.		Abm. mm	
FP DE SPHG 000	51 01	58x11x34 H	
	51 XB		
	52 07		
	5A 01		
	59 00		

LAGERHALTIG

AUF ANFRAGE



HALTERUNGEN

ART.	
FP DE SPSU 000	59 05

Halterungspaar für Kästen der Serie Delta



Verschluss des Deckels mit Sicherheitsplombe



DECKEL

ART.		Abm. mm	
FP DE 64SE 000	51 01	610x400	
	51 XB		
	52 07		
	5A 01		
	59 00		

LAGERHALTIG

AUF ANFRAGE



Farbauswahl Material/Farben	51 01 Polypropylen, grau	51 XB Polypropylen, türkis	52 07 PP - ESD schwarz	59 00 PP - weiß lebensmitteleauglich	5A 01 GRÜNES wiederverwertetes Material	WEITERE FARBEN AUF ANFRAGE
	<p>LAGERHALTIG AUF ANFRAGE</p>					

TECHNISCHE ABMESSUNGEN DES KASTENS

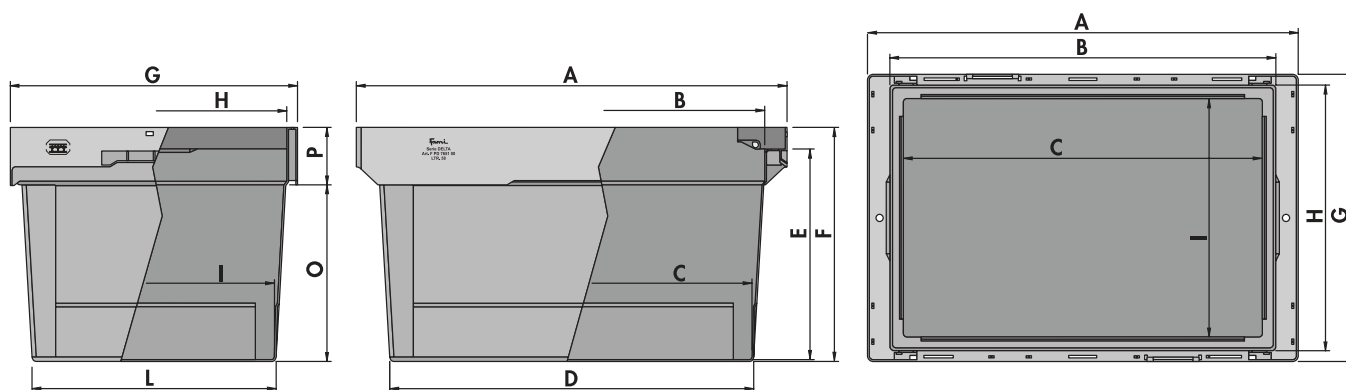

ART. KÄSTEN	A	B	C	D	E	F	G	H	I	L	O	P
FP DE 6422 A 00	601	540	501	509	292	325	401	373	330	339	245	81
FP DE 6432 A 00	601	524	455	535	178	201	398	368	338	345	141	60
FP DE 6442 A 00	601	540	499	508	394	426	400	372	329	338	326	100
FP DE 6422 B 00	601	532	501	508	192	229	400	370	330	339	174	50
FP DE 6432 B 00	601	540	501	509	292	330	401	373	330	339	245	81
FP DE 6442 B 00	601	540	499	508	394	431	400	372	329	338	326	100
FP DE 6422 C 00	611	532	501	508	192	239	400	370	330	339	174	50
FP DE 6432 C 00	611	540	501	509	292	340	401	373	330	339	245	81
FP DE 6442 C 00	611	540	499	508	394	441	400	372	329	338	326	100

