

# ZEUS

Die Polypropylenkästen der Serie Zeus erfüllen ganz spezifische Bedürfnisse im Rahmen der Aufbewahrung, Beförderung und Lagerung von Waren. Sie sind handlich, leicht und dank des vollkommen glatten Inneren einfach zu reinigen und mit einer robusten Kante ausgestattet, die ein stabiles und sicheres Übereinanderstellen ermöglicht. Dank der Stapelbarkeit und der erheblichen Aufnahmefähigkeit nutzen sie den verfügbaren Platz ideal.

# SEITLICHE BODENVERSTÄRKUNG

Dank der seitlichen Bodenverstärkung können die Kästen auch bei voller Last mit maximaler Sicherheit gestapelt werden.



## BÖDEN

geschlossener Boden **A**



Boden mit Rippen **B**



Boden mit 45°-Rippen **C**



## GRIFFE - WÄNDE



Griffleiste

geschlossene Wände

## CODIERUNG Zeus

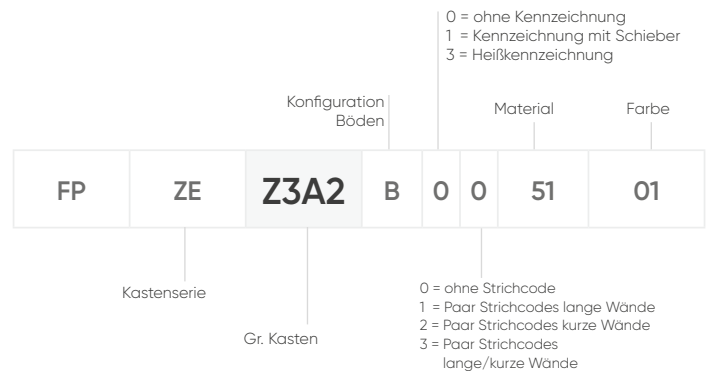

## ROHSTOFF



51 01

Polypropylen,  
grau



51 02

Polypropylen,  
grün



51 03

Polypropylen,  
rot



51 04

Polypropylen,  
blau



51 05

Polypropylen,  
gelb



54 01

Ecogreen,  
grau



52 07

PP - ESD  
schwarz

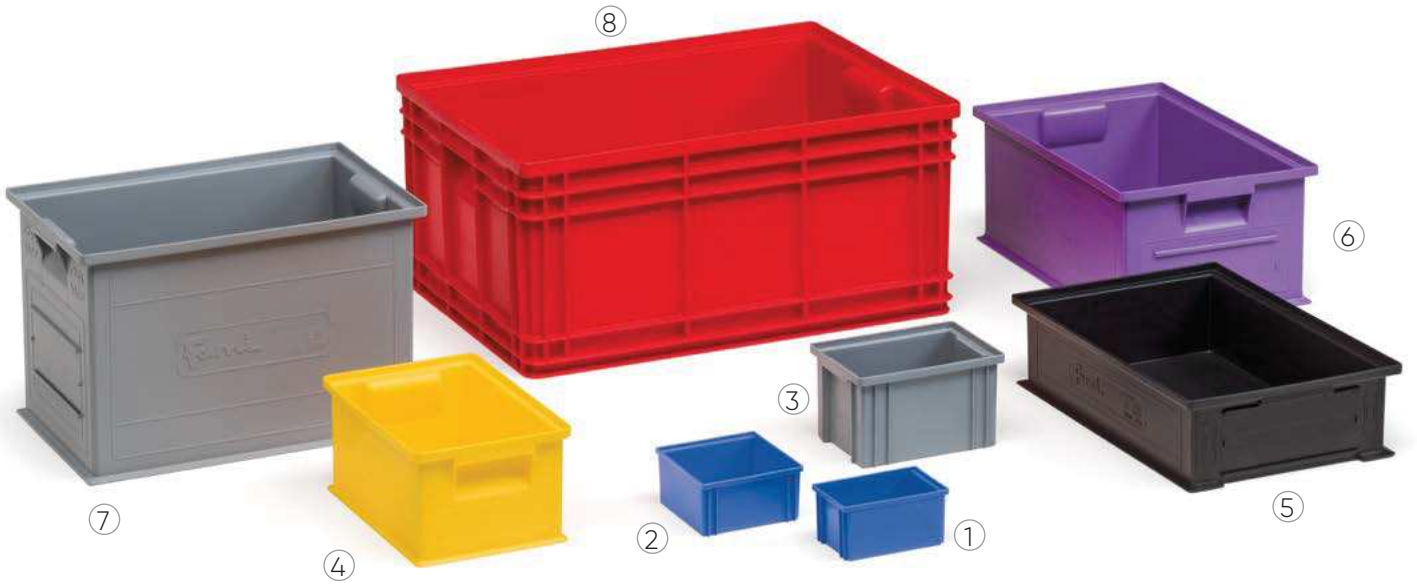

## VERPACKUNG 1 - KARTON

Bez. Kasten	ART.	Abm. Karton mm	L
① Gr. 701	FW ZE Z701 A 00	51 01	470x300x350 H 50 0,9
		51 02	
		51 03	
		51 04	
		51 05	
		54 01	
		52 07	
② Gr. 702	FW ZE Z702 A 00	51 01	430x430x410 H 54 1,4
		51 02	
		51 03	
		51 04	
		51 05	
		54 01	
		52 07	
③ Gr. 272-2	FW ZE Z002 B 00	51 01	640x460x500 H 54 3,6
		51 02	
		51 03	
		51 04	
		51 05	
		54 01	
		52 07	

## VERPACKUNG 2 - 1/2 PALETTE

Bez. Kasten	ART.	Abm. 1/2 Palette mm	L
NICHT VERFÜGBAR			
NICHT VERFÜGBAR			
NICHT VERFÜGBAR			



## ABMESSUNGEN KÄSTEN mm

- ① 145x90x70 H
- ② 145x140x70 H
- ③ 200x140x130 H Gr. **272-2**
- ④ 300x200x145 H Gr. **272-3A2**
- ⑤ 450x300x120 H Gr. **272-4A2**
- ⑥ 450x300x200 H Gr. **272-4**
- ⑦ 450x300x300 H Gr. **272-4A5**
- ⑧ 630x450x300 H Gr. **272-5**

### VERPACKUNG 3 - PALETTE

Bez. Kasten	ART.	Abm. Palette mm	L
-------------	------	-----------------	---

NICHT VERFÜGBAR

NICHT VERFÜGBAR

③	FY ZE Z002 B 00	51 01	1400x1100x1660 H	810	3,6
		51 02			
		51 03			
		51 04			
		51 05			
		54 01			
		52 07			
Gr. 272-2					

geschlossener Boden



A

Boden mit Rippen



B



VERPACKUNG 1  
Menge pro Karton



VERPACKUNG 2  
Anz. Kästen  
pro 1/2 Palette



VERPACKUNG 3  
Anz. Kästen  
pro Palette



Litervolumen  
pro Einzelkasten



PERSONALISIERTE  
KENNZEICHNUNG  
siehe S. 9



52 07

PP - ESD  
schwarz



WEITERE FARBEN  
AUF ANFRAGE















LAGERHALTIG



AUF ANFRAGE

## VERPACKUNG 1 - KARTON

## VERPACKUNG 2 - 1/2 PALETTE

Bez. Kasten	ART.		Abm. Karton mm			Bez. Kasten	ART.		Abm. 1/2 Palette mm				
④ Gr. 272-3A2	FW ZE Z3A2 B 00		360x640x980 H	21	8,7							NICHT VERFÜGBAR	
													51 01
													51 02
													51 03
													51 04
													51 05
													54 01
52 07													
⑤ Gr. 272-4A2	FW ZE Z4A2 B 00		640x480x960 H	16	16,2							NICHT VERFÜGBAR	
													51 01
													51 02
													51 03
													51 04
													51 05
													54 01
52 07													
⑥ Gr. 272-4	FW ZE Z004 B 00		640x480x960 H	10	27							NICHT VERFÜGBAR	
													51 01
													51 02
													51 03
													51 04
													51 05
													54 01
52 07													
⑦ Gr. 272-4A5	FW ZE Z4A5 C 00		520x640x900 H	6	40,5							NICHT VERFÜGBAR	
													51 01
													51 02
													51 03
													51 04
													51 05
													54 01
52 07													
⑧ Gr. 272-5	FW ZE Z005 C 00		630x450x900 H	3	85								
													51 01
													51 02
													51 03
													51 04
													51 05
													54 01
52 07													
⑧ Gr. 272-5	FX ZE Z005 C 00		1300x1000x1050 H	12	85								
													51 01
													51 02
													51 03
													51 04
													51 05
													54 01
52 07													

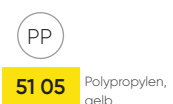
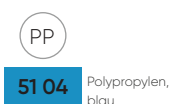
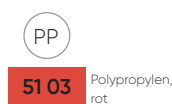

## VERPACKUNG 3 - PALETTE

Bez. Kasten	ART.	Abm. Palette mm				
④ Gr. 272-3A2	FY ZE Z3A2 B 00	51 01	1350x1100x2000 H	252	8,7	
		51 02				
		51 03				
		51 04				
		51 05				
		54 01				
52 07						
	⑤ Gr. 272-4A2	FY ZE Z4A2 B 00	51 01	1300x1100x1900 H	128	16,2
			51 02			
			51 03			
			51 04			
			51 05			
54 01						
52 07						
	⑥ Gr. 272-4	FY ZE Z004 B 00	51 01	1300x1100x2000 H	80	27
			51 02			
			51 03			
			51 04			
			51 05			
54 01						
52 07						
	⑦ Gr. 272-4A5	FY ZE Z4A5 C 00	51 01	1300x1100x2160 H	56	40,5
			51 02			
			51 03			
			51 04			
			51 05			
54 01						
52 07						
	⑧ Gr. 272-5	FY ZE Z005 C 00	51 01	1300x1000x2110 H	28	85
			51 02			
			51 03			
			51 04			
			51 05			
54 01						
52 07						

## ABMESSUNGEN KÄSTEN mm

- ④ 300x200x145 H Gr. [272-3A2](#)
- ⑤ 450x300x120 H Gr. [272-4A2](#)
- ⑥ 450x300x200 H Gr. [272-4](#)
- ⑦ 450x300x300 H Gr. [272-4A5](#)
- ⑧ 630x450x300 H Gr. [272-5](#)

Boden mit Rippen



B

Boden mit 45°-Rippen



C



VERPACKUNG 1  
Menge pro Karton



VERPACKUNG 2  
Anz. Kästen  
pro 1/2 Palette



VERPACKUNG 3  
Anz. Kästen  
pro Palette



Litervolumen  
pro Einzelkasten



PERSONALISIERTE  
KENNZEICHNUNG  
siehe S. 9



52 07

PP - ESD  
schwarz



WEITERE FARBEN  
AUF ANFRAGE

LAGERHALTIG

AUF ANFRAGE

# ZEUS





### ETIKETTEN

ART.	Abm. Etiketten mm	Etikettenanzahl pro Blatt	Für Kasten art.
<b>F PL 9140 00 00</b>	189x82	3	F_ ZE <b>Z4A2 B</b> 00
<b>F PL 9160 00 00</b>	189x85	3	F_ ZE <b>Z004 B</b> 00 F_ ZE <b>Z4A5 C</b> 00 F_ ZE <b>Z005 C</b> 00



## TECHNISCHE ABMESSUNGEN DES KASTENS

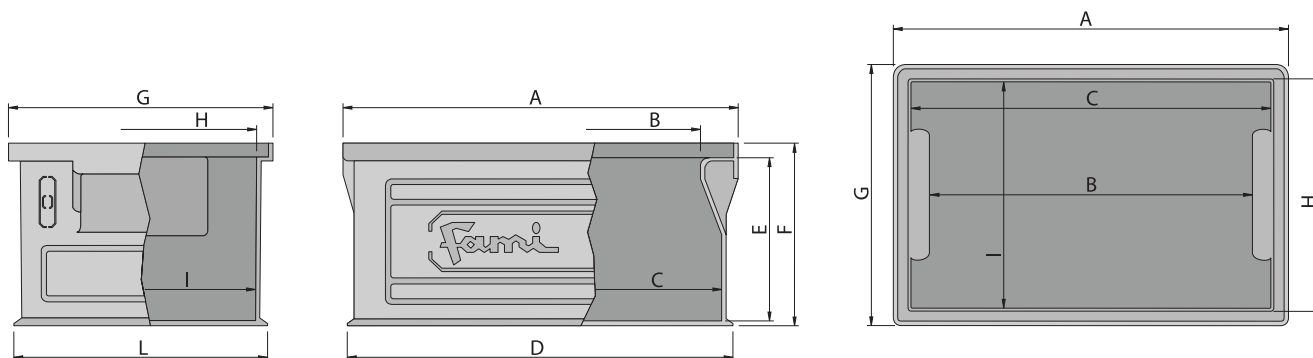

ART. KÄSTEN	A	B	C	D	E	F	G	H	I	L
FP ZE <b>Z701 A</b> 00	144	127	123	137	63	70	91	84	81	84
FP ZE <b>Z702 A</b> 00	144	126	124	137	63	70	139	132	126	132
FP ZE <b>Z002 B</b> 00	211	178	187	202	110	123	148	129	125	140
FP ZE <b>Z3A2 B</b> 00	311	255	284	303	130	144	209	184	182	201
FP ZE <b>Z4A2 B</b> 00	463	427	423	453	105	120	313	277	275	304
FP ZE <b>Z004 B</b> 00	464	403	425	452	181	197	312	288	277	301
FP ZE <b>Z4A5 C</b> 00	466	407	426	453	285	301	314	281	276	302
FP ZE <b>Z005 C</b> 00	655	570	604	638	276	299	471	435	429	458